

Features

- Glass Passivated Die Construction
- Diffused Junction
- Ultra-Fast Recovery Time for High Efficiency
- Low Forward Voltage Drop, High Current Capability, and Low Power Loss
- Surge Overload Rating to 30A Peak
- Ideally Suited for Automated Assembly
- Plastic Material: UL Flammability Classification Rating 94V-0

Mechanical Data

- Case : Moulded plastic, JEDEC SOD123 / MINI SMA
- Terminals : Solder plated, solderable per MIL-STD-750, Method 2026
- Polarity : Indicated by cathode band
- Mounting Position : Any
- Weight : 0.04 gram

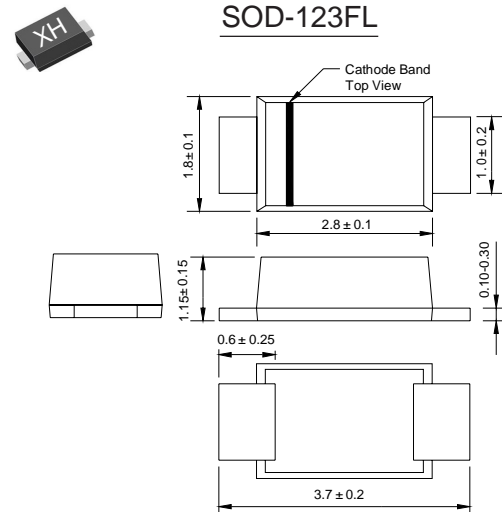

Dimensions in inches and (millimeters)

Maximum Ratings and Electrical Characteristics T_A = 25°C unless otherwise specified

Single phase, half wave, 60Hz, resistive or inductive load.
For capacitive load, derate current by 20%.

Characteristic	Symbol	US1AW	US1BW	US1DW	US1GW	US1JW	US1KW	US1MW	Unit
Peak Repetitive Reverse Voltage	V _{RRM}	50	100	200	400	600	800	1000	V
Working Peak Reverse Voltage	V _{RWM}								
DC Blocking Voltage	V _R								
RMS Reverse Voltage	V _{R(RMS)}	35	70	140	280	420	560	700	V
Average Rectified Output Current @ T _T = 75°C	I _O	1.0							A
Non-Repetitive Peak Forward Surge Current 8.3ms Single half sine-wave Superimposed on Rated Load (JEDEC Method)	I _{FSM}	30							A
Forward Voltage Drop @ I _F = 1.0A	V _{FM}	1.0		1.3		1.7		V	
Peak Reverse Current @ T _A = 25°C at Rated DC Blocking Voltage @ T _A = 100°C	I _{RM}	5.0 100							μA
Reverse Recovery Time (Note 2)	t _{rr}	50				75			ns
Typical Junction Capacitance (Note 1)	C _j	20				10			pF
Typical Thermal Resistance, Junction to Terminal	R _{θJT}	30							°C/W
Operating and Storage Temperature Range	T _J , T _{STG}	-65 to +150							°C

- Notes: 1. Measured at 1.0MHz and applied reverse voltage of 4.0V DC.
2. Measured with I_F = 0.5A, I_R = 1.0A, I_{rr} = 0.25A.

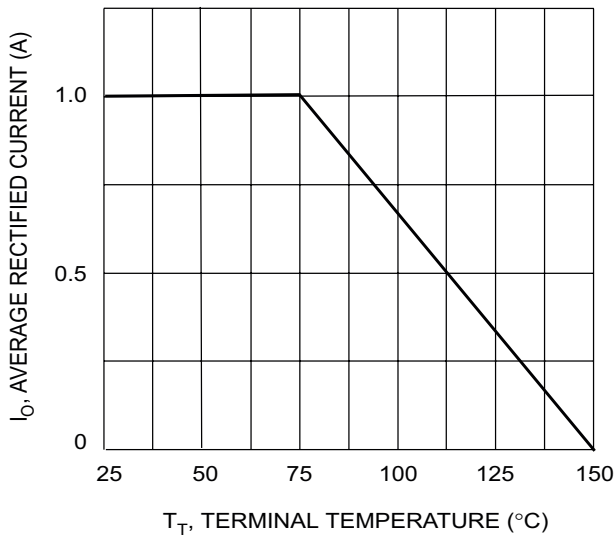

Fig. 1 Forward Current Derating Curve

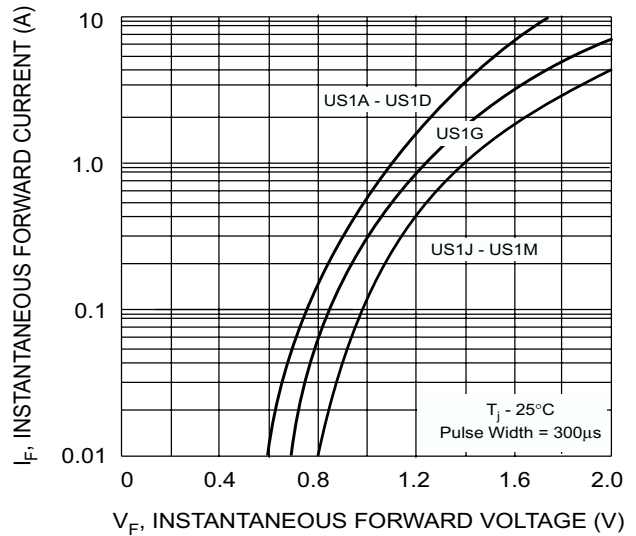

Fig. 2 Typical Forward Characteristics

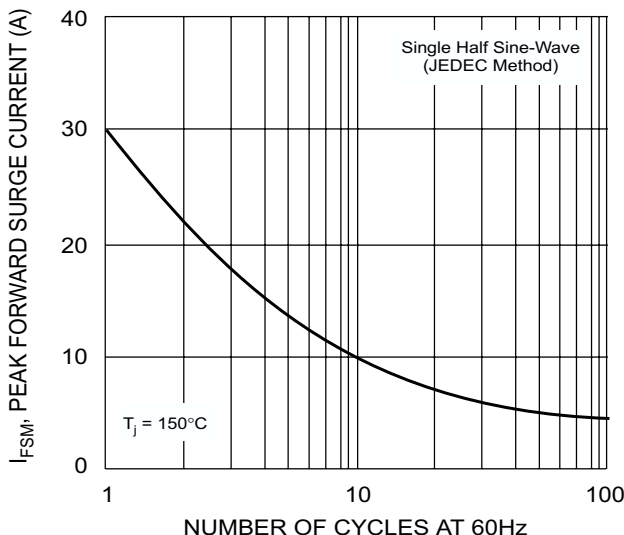

Fig. 3 Forward Surge Current Derating Curve

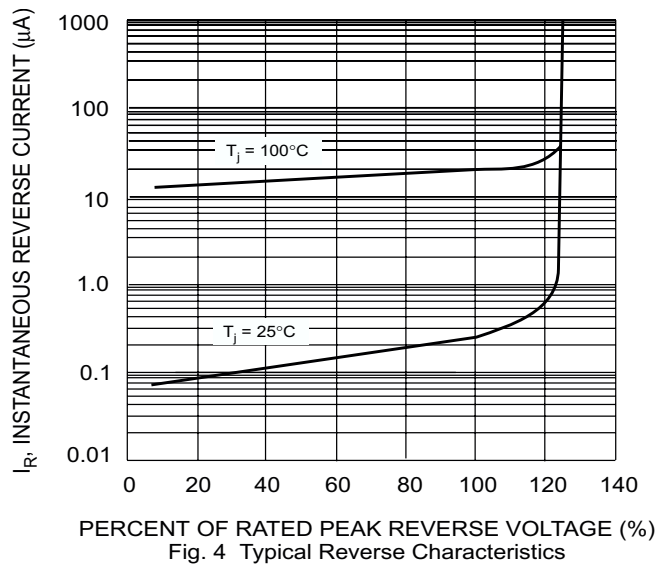
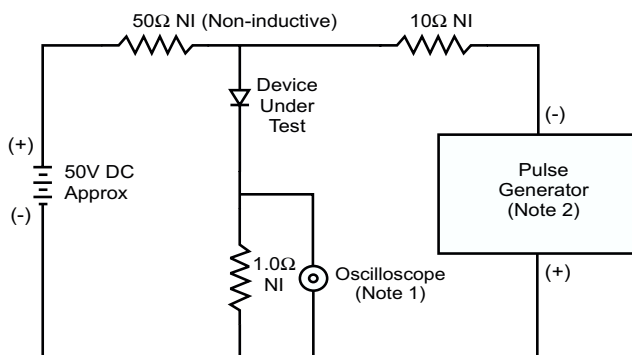
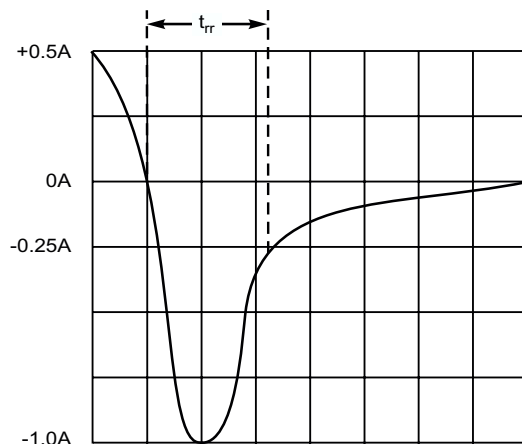

Fig. 4 Typical Reverse Characteristics



- Notes:
1. Rise Time = 7.0ns max. Input Impedance = 1.0MΩ, 22pF.
2. Rise Time = 10ns max. Input Impedance = 50Ω.



Set time base for 50/100 ns/cm

Fig. 5 Reverse Recovery Time Characteristic and Test Circuit